

Article number: 07109050001

Description: Universal joint single 0.109.050.001  
S=90 X= Bore with keyway

## Measures

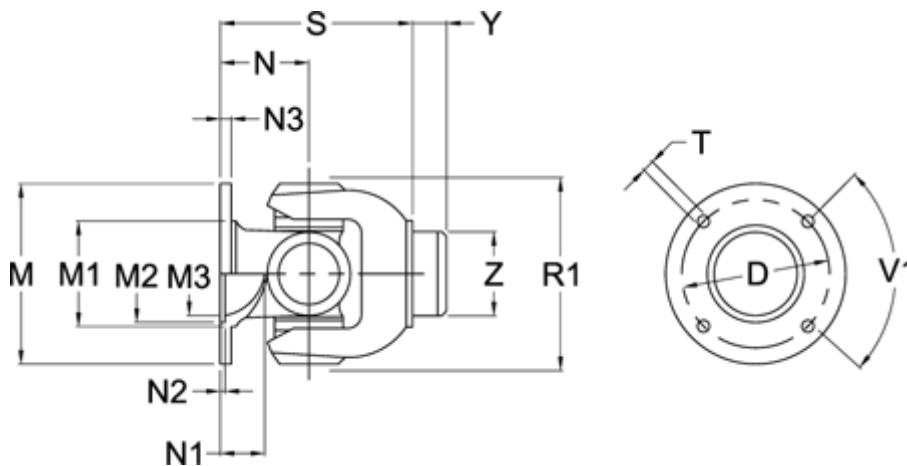

D	= 74,5 +-0,1	N2	= 2,5 +0,3	Z = 46.25
Flange diameter M	= 90	N3	= 6	
M1	= 56	Number of Flangeholes	= 4	
M2	= 47	R1	= 86	
M3	= 39	S min	= 90	
Max. Bending Angle degrees	= 20	T	= 8 B12	
N	= 42	V1 degrees	= 90	
N1	= 18	Y	= 14	